

# Specification for Approval

## 产品承认书

Customer:

Customer P/N:

VOOHU P/N:

WHSM24P02N0

Version No.:

V0.1

Description:

10G BASE-T

Laser Marking

SUZHOU VOOHU Company Approval		Customer Approval (客户承认签章)
<b>DRAWN</b>	Geoffrey.Song	
<b>CHECKED</b>	Sunny.Xu	
<b>APPROVED</b>	Elvis. Song	
日期DATE:2026/05/19		日期DATE: 2026/05/19

Please Return One Copy to Us After Approved,TKs! (承认后请回寄一份,谢谢)

 **VOOHU 沃虎**  
造沃虎·真靠谱

苏州沃虎电子科技有限公司  
SuZhou Voohu Electronic Tech.Co.,Ltd

地址: 江苏省苏州市吴江区开平商务中心G栋13楼  
ADD: Building A, Alpha Building, Wujiang District,  
Suzhou City, Jiangsu Province

TEL: 400 1048 018      WEB: www.voohu.cn  
+86 13338655578      E-MAIL: wohu@wohu-tek.com



**A. MECHANICAL(unit:mm)**

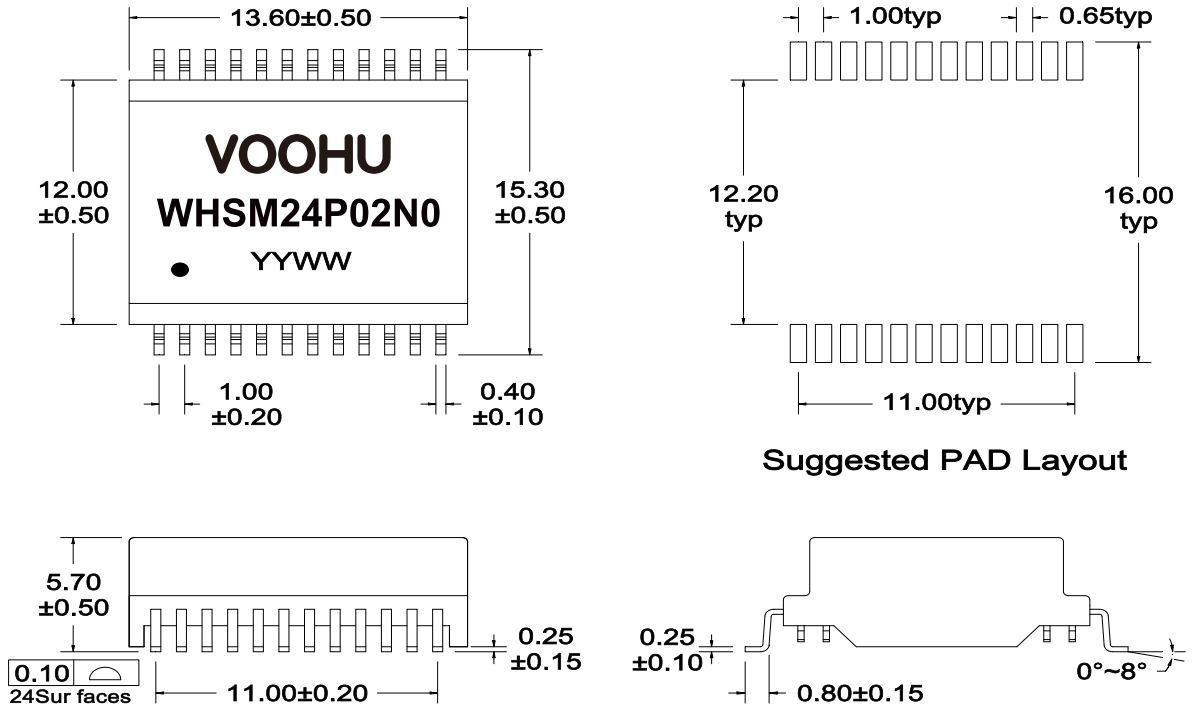

**B. SCHEMATICS**

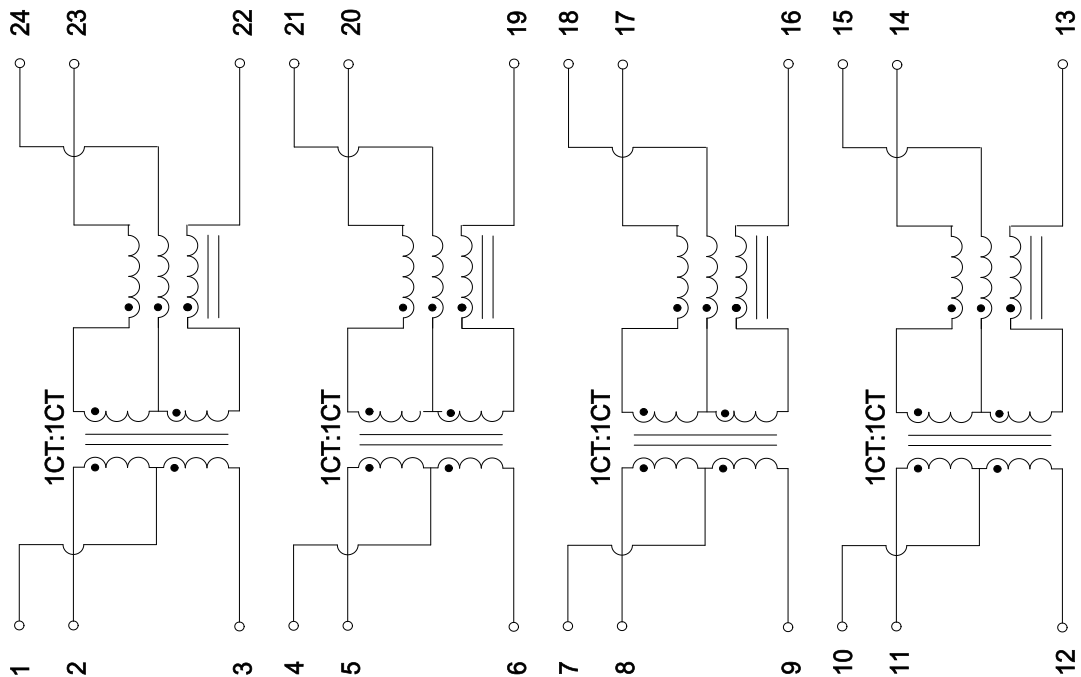

DESCRIPTION	PART NO.	REV:R0
10G BASE-T	WHSM24P02N0	PAGE:2/4

### C. ELECTRICAL SPECIFICATIONS @25°C

Unless Otherwise Specified, Testing is Performed at 25°C ± 5°C

1. OCL: 120 uH Min @100KHz 0.1V
2. Leakage Inductance: 0.5uH Max @ 100KHz, 0.1V
3. DCR: 900mΩ Max
4. Turns Ratio: 1CT:1CT±5%
5. Insertion Loss: -1.2dB max @ 1~200 MHz  
-1.5dB max @ 200~300 MHz  
-2.0dB max @ 300~400 MHz  
-3.0dB max @ 400~500 MHz
6. Return Loss: -18 dB Min @ 1~100 MHz  
-16 dB Min @ 100~200 MHz  
-12 dB Min @ 200~300 MHz  
-10 dB Min @ 300~400 MHz  
-8 dB Min @ 400~500 MHz
7. Cross Talk: -25 dB Typ @ 1-500 MHz
8. Common Mode Rejection: -25 dB Typ @ 1-500 MHz
9. Isolation Hipot: 1500VAC 1mA 60S
10. Operating temperature -40°C to +85°C
11. Storage temperature -40°C to +85°C

### D. RECOMMEND REFLOW SOLDERING CURVE

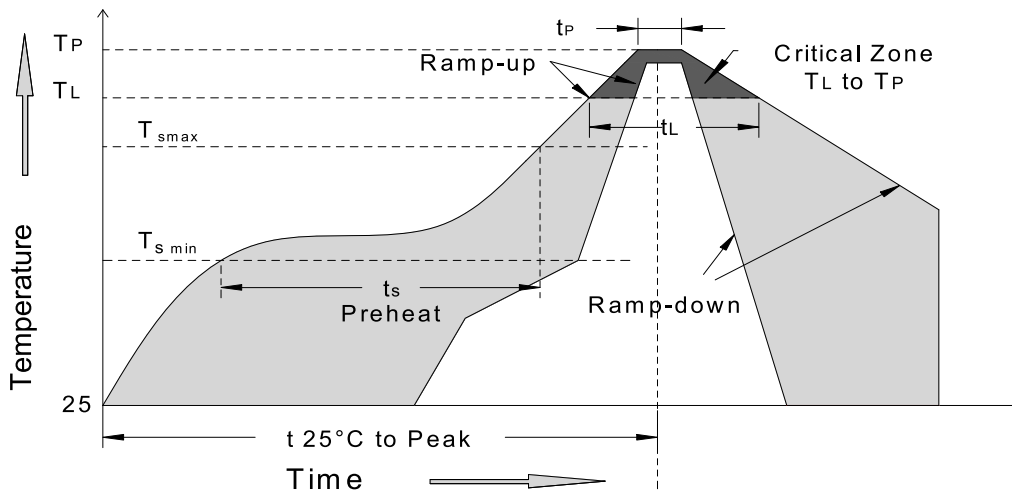

MSL:

Grade: 1 level. Floor life: 0.5 year Condition: ≤30°C/60%RH.

Ramp up rate=3°C/s max Ramp down rate=6°C/s max

TL=217°C tL=60s-150s Tp=250+/-3°C Time within 3°C of actual Peak Temperature (tp): 20~40s

Ts min=150°C Ts max=200°C Ts min to Ts max: 60s-180s, 25°C to peak Temperature: 8minutes max

DESCRIPTION	PART NO.	REV:R0
10G BASE-T	WHSM24P02N0	PAGE:3/4

**E. PACKAGE INFORMATION**

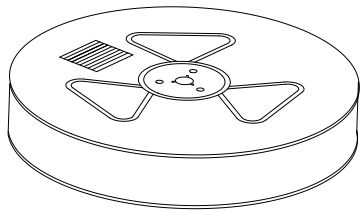
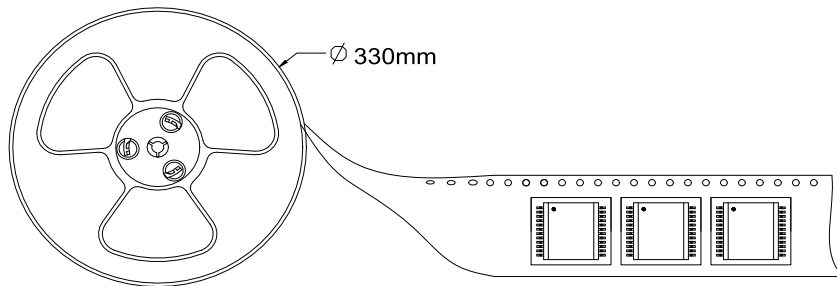
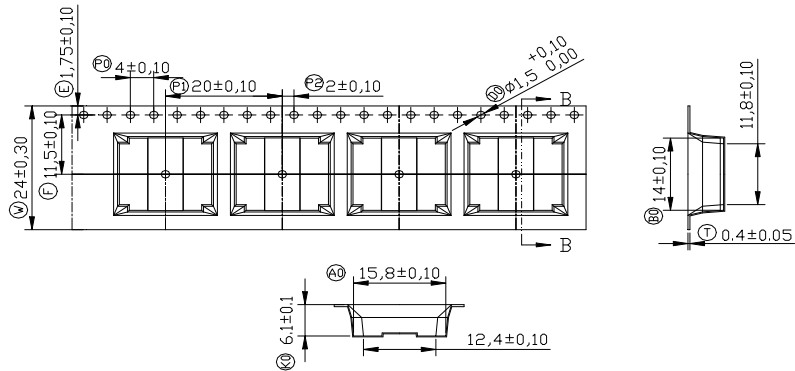

Two Reel

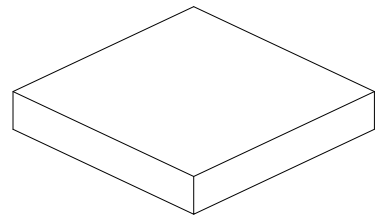

Inner Carton

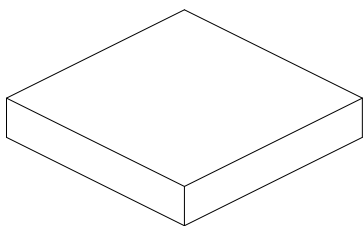

Five Inner Carton

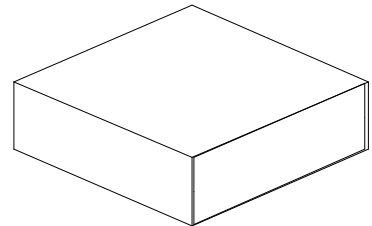

Export Carton

Package Quantity:

One Reel=450Pcs

One Inner Carton=450\*2=900Pcs

One Export Carton=900\*5=4500Pcs

DESCRIPTION	PART NO.	REV:R0
10G BASE-T	WHSM24P02N0	PAGE:4/4